

Ocean Enclosures

PCB Drawing of Open Top Enclosure, (OT-70) Din rail & wall mounting

DRAWING OF TOP PCB

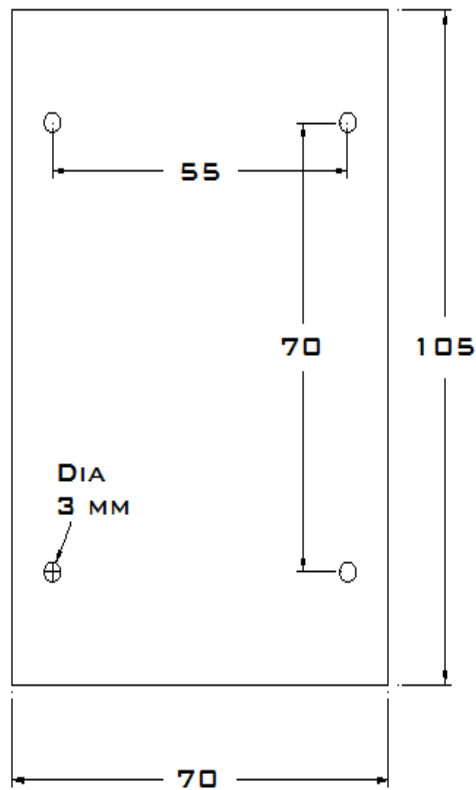

DRAWING OF BOTTOM PCB

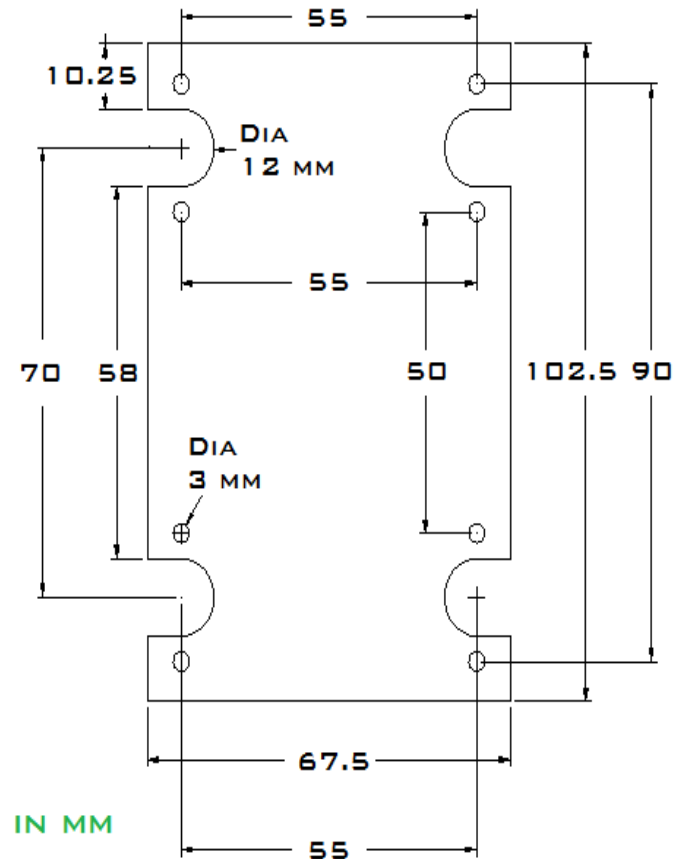

ALL DIMENSIONS ARE IN MM

Electroconnect Systems

J-112, Ansa Industrial Estate, Saki Vihar Road, Sakinaka,
Mumbai – 400 072. (India)

Phone Nos.: 28471917/60

Email ID: electronicenclosures@gmail.com

Website: www.oceanenclosures.com